

1

2

3

4

5

6

A

A

B

B

C

C

D

D

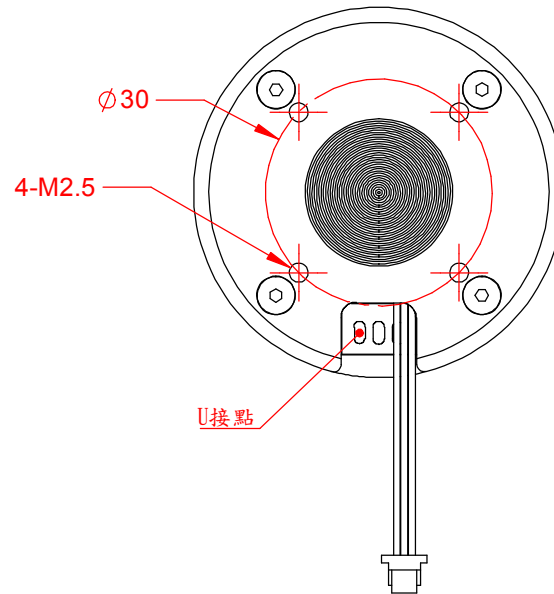
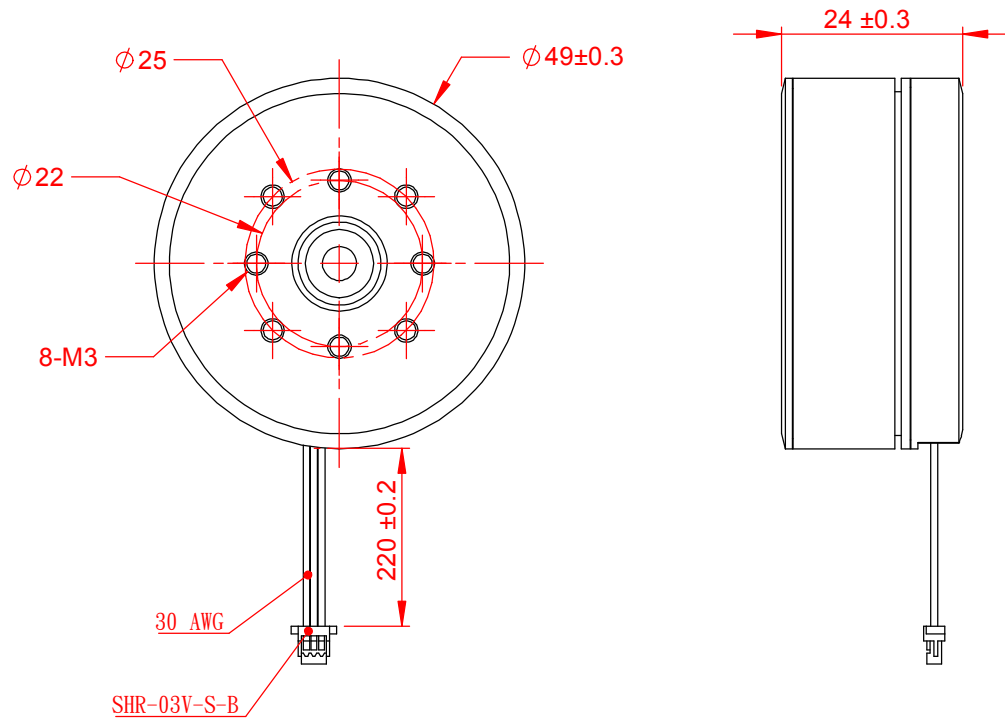

Encoder Line		
NO	Color	Features
1	Black	-
2	Red	+
3	White	PWM
3.3-5VDC		

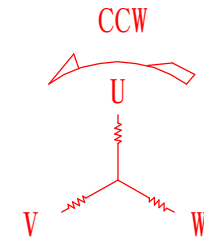

註記：
Encoder : AS5048A

MODEL		NO LOAD		AT MAXIMUM EFFICIENCY				
JB49-C2E6B687		SPEED	CURRENT	SPEED	CURRENT	TORQUE	OUTPUT	EFF
NOMINAL 12V DC		RPM	A	RPM	A	g-cm	W	%
		539	0.07	432	0.282	613.181	2.781	82.32

第三角法	製圖	Sam	Cheshire Electric Copmany, LLC		
所有尺寸單位都是mm(除非有另外指定)	設計	Sam	Name: JB49-C2E6B687		
	審核	Adam	Part No: Outer rotor brushless motor		
	複核		Qty: 1	Rev: A	
繪製比例	1:1	繪製日期	2017/6/15		

1

2

3

4

5

6